



eclipse

ECLIPSE Downlight - Blue and White

DL55



PART DESCRIPTION	DL55 ECLIPSE DOWNLIGHT
Part Number	60-0485 - ECLIPSE Downlight DL55 - Blue and White (White Finish) 60-0486 - ECLIPSE Downlight DL55 - Blue and White (Black Finish)
Available Colors	Blue & White (5000 K)
LED Type	2 x 3W Blue LEDs / 2 x 3W White LEDs
Fixture Lumens	172
Warranty	3 Years
Customer Control Options	On/Off Switch ECLIPSE Command Center
Electrical Installation	Simple 2 Wire Installation

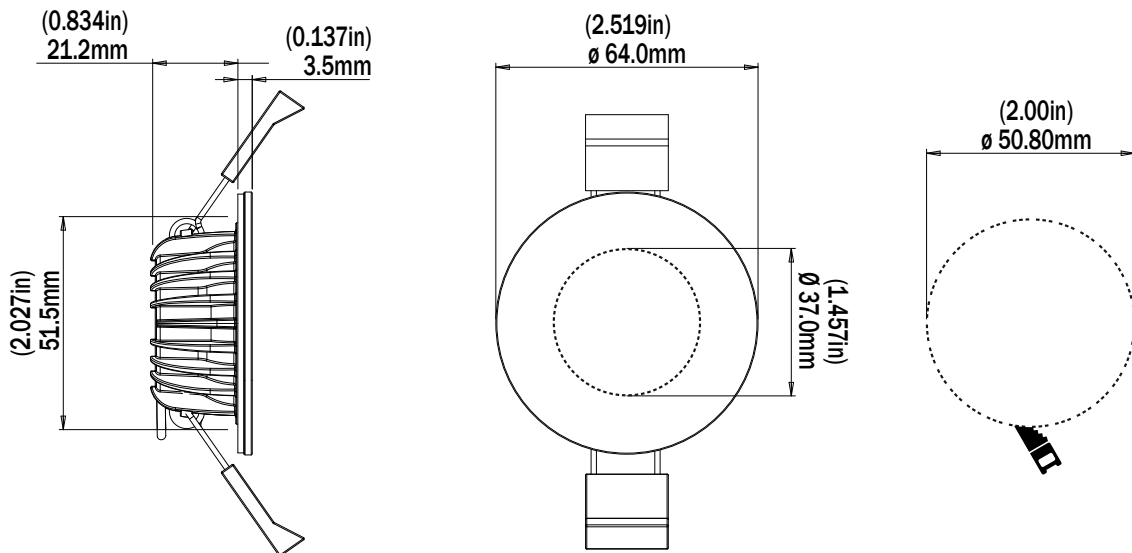

TECHNICAL

Driver	Internal Driver
Supply Voltage Range	12V DC Only (10 - 15V DC)
Max Current Draw (12V DC)	0.4A
Surge Protection	Yes
Low Voltage Protection	Yes
Auto Power Control	Yes
“Soft Start” Electronics Protection	Yes
Reverse Polarity Protection	Yes
In Rush Current Protection	Yes
Power Line Noise Suppression	Yes
ISO 8846 (Ignition Protection)	Yes

PHYSICAL

Ingress Protection	IP67
Front Diameter (Bezel)	64.0mm (2.519")
Profile (When Installed)	3.0mm (0.118")
Profile (Gasket Removed)	2.0mm (0.078")
Depth	21.2mm (0.834")
Hole Diameter for fitting	50.8mm (2.0")
Construction	E-Coating & Powder Coating
Mechanical Installation	Stainless Steel Spring Clips Marine Adhesive (Optional)
Weight	75g (2.7 oz)

ACCESSORIES

ECLIPSE Command Center	60-0495
Expansion Module (Single Zone)	60-0496
Expansion Module (Double Zone)	60-0497

LIGHTING SYSTEM FUNCTIONALITY (ON/OFF SWITCH)

On/Off Control	Yes
Switch Between Color Blue and White	Yes
Dimming Control	No

LIGHTING SYSTEM FUNCTIONALITY (ECLIPSE COMMAND CENTER)

From Smart Device/MFD:

On/Off Control	Yes
Switch Between Color Blue and White	Yes
Dimming Control	Yes
Zone Control	Yes
Strobe	Yes

From Momentary Switch (Optional):

On/Off Control	Yes
Switch Between Color Blue and White	Yes
Dimming Control	Yes